

OBS! Types of accessories must be approved by appropriate fire class and manufacturer. Please contact dealer for getting approved list.
Position of accessories should be defined before production of the door. It is responsibility of the customer, architect and dealer.

If door is delivered without accessories, please follow guidelines below:

Locks and strikers assembling

Valid for lock case, electric/mechanical strike plate.

Adjustment.

Intumescent cloth applied for lock case and electric strike plate the whole length of the recess, not for mechanical strike plate. Cut out in the intumescent cloth adjusted to necessary lock case holes. No cut out for electric strike plate.

Assembly.

Slide in the intumescent cloth into recess in profile. Then assemble the lock case (or electric strike) to fixate the intumescent cloth.

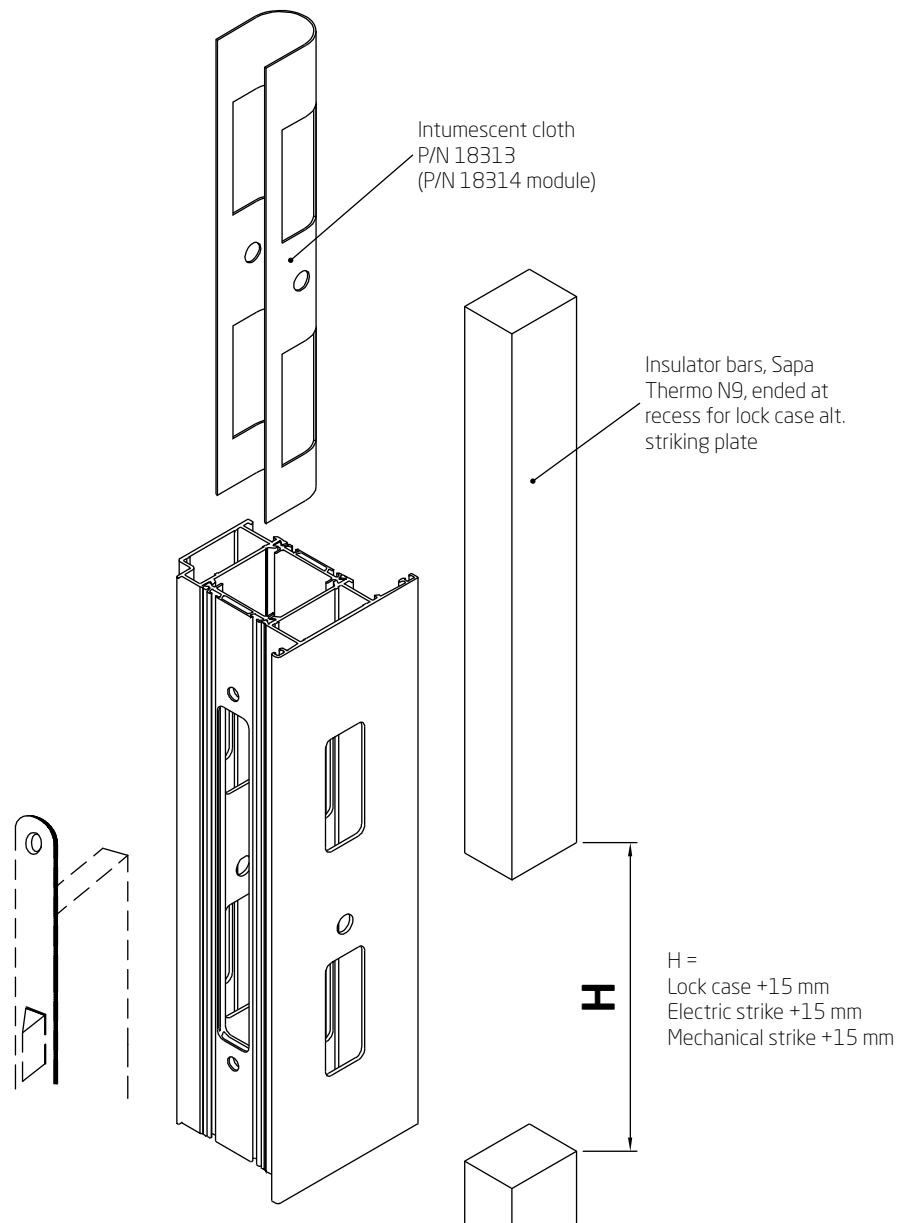

NB! Intumescent cloth will be included in delivery.

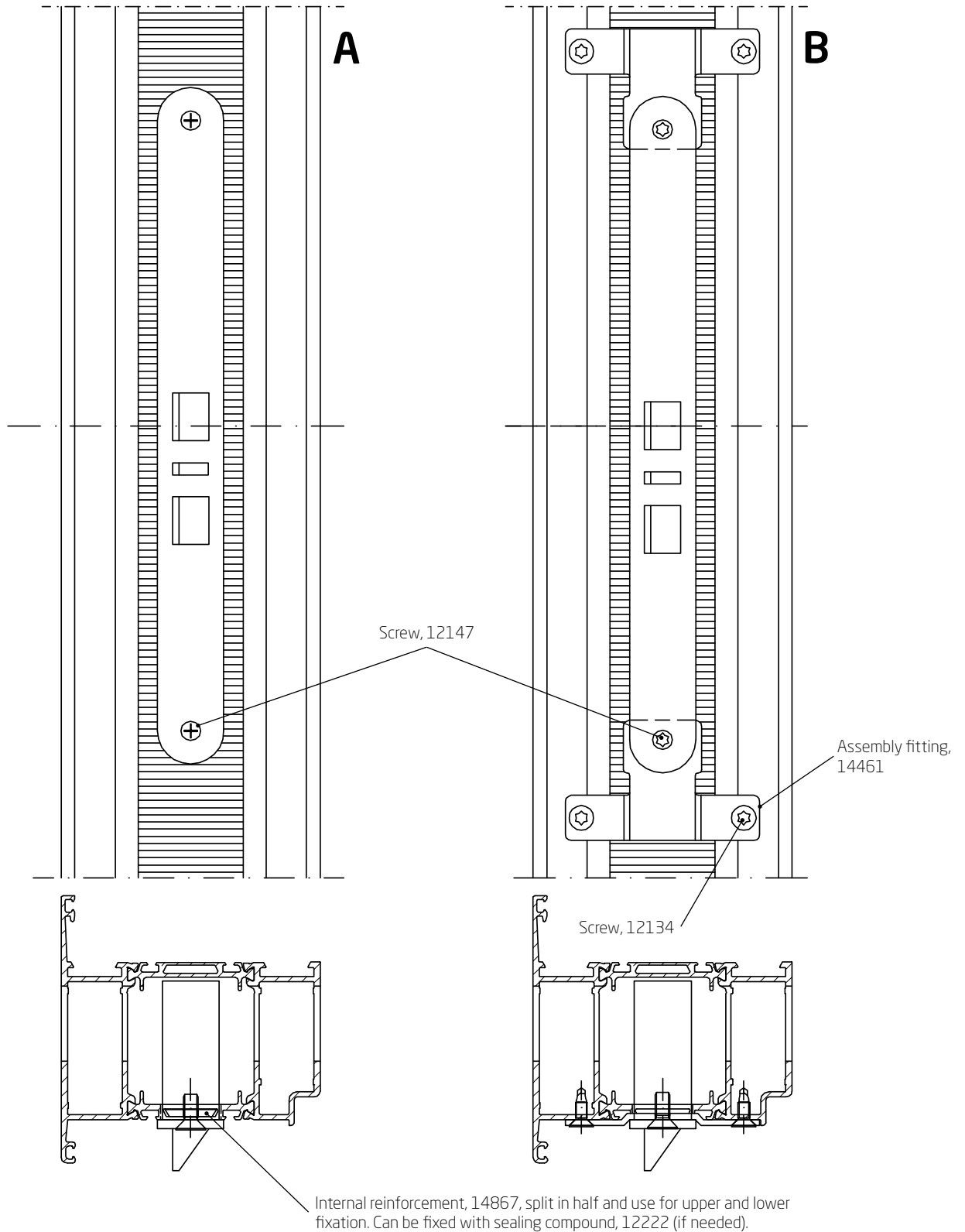

NB! Alternative A is factory standard. Reinforcement 14867 and screws will be included in delivery.

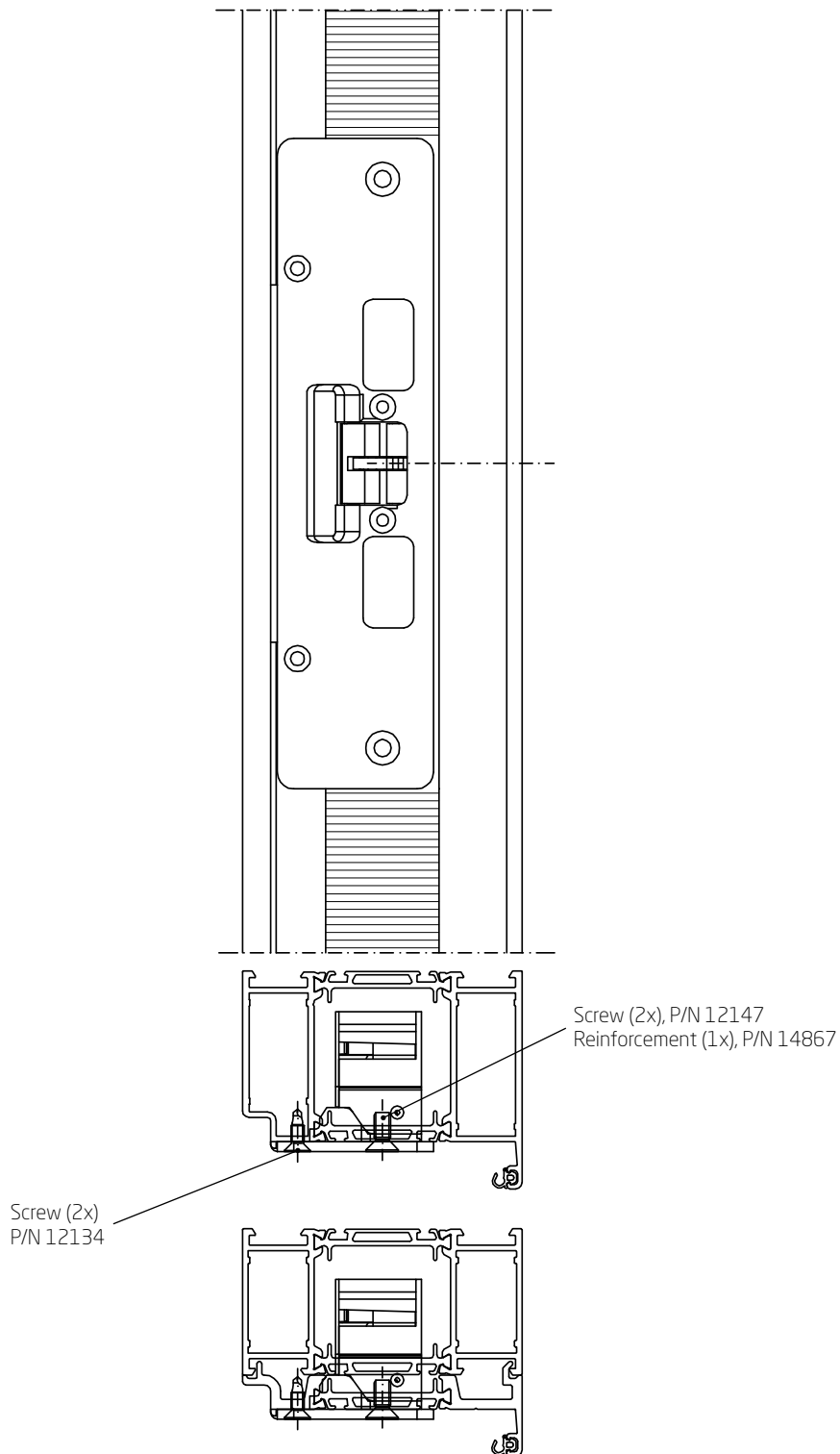

NB! Reinforcement 14867 and screws will be included in delivery. Drawing shows installation of ASSA 900-series electric striker (Faceplate ASSA 986). The same principal is used for STEP 90 (Faceplate ST4086), STEP92 (Faceplate ST9586) series electric strikers.

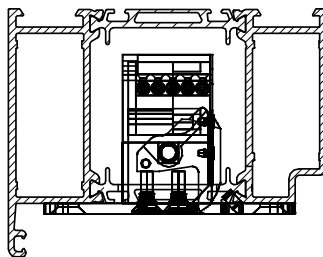
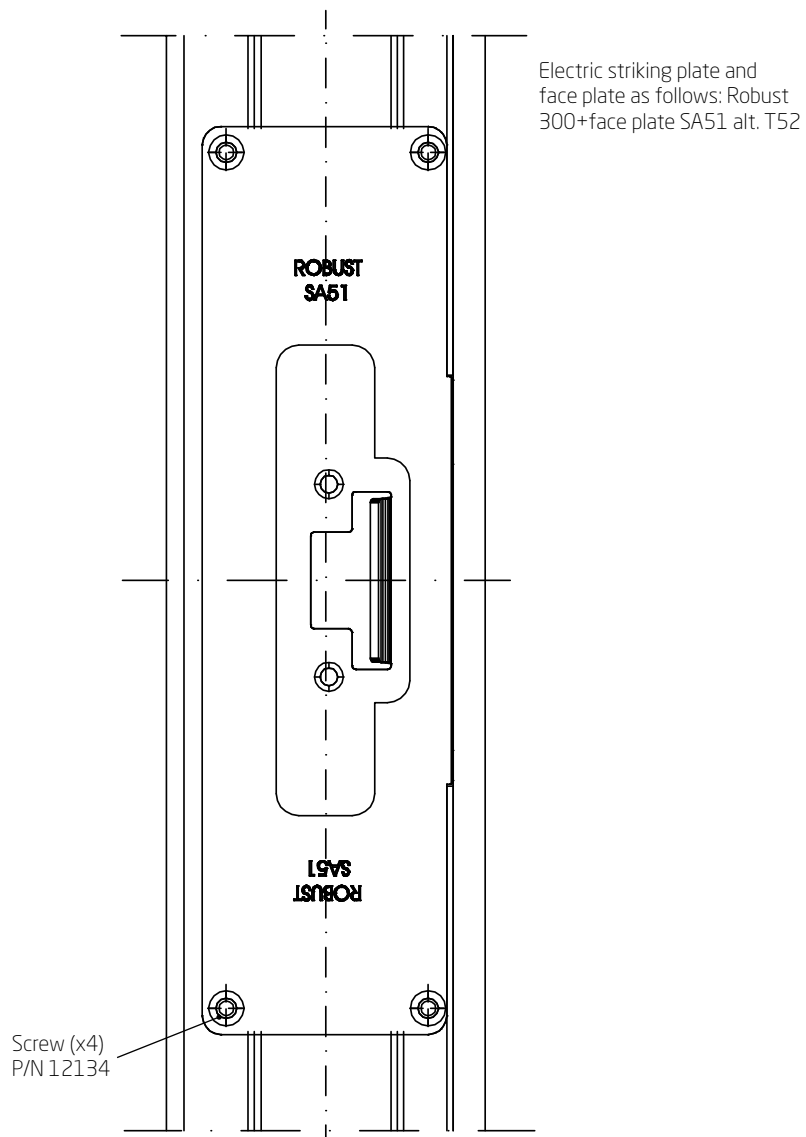

NB! Fastening screws will be included in delivery.

Door closer/automatics assembling:

- A**= Mounting on hinge side (overhead from installation)
- B**= Mounting on hinge side (standard installation)
- C**= Mounting on hinge opposite side (overhead frame installation)
- D**= Mounting on hinge opposite side (standard installation)

Examples on the right for outward opening door complies with inward opening door.

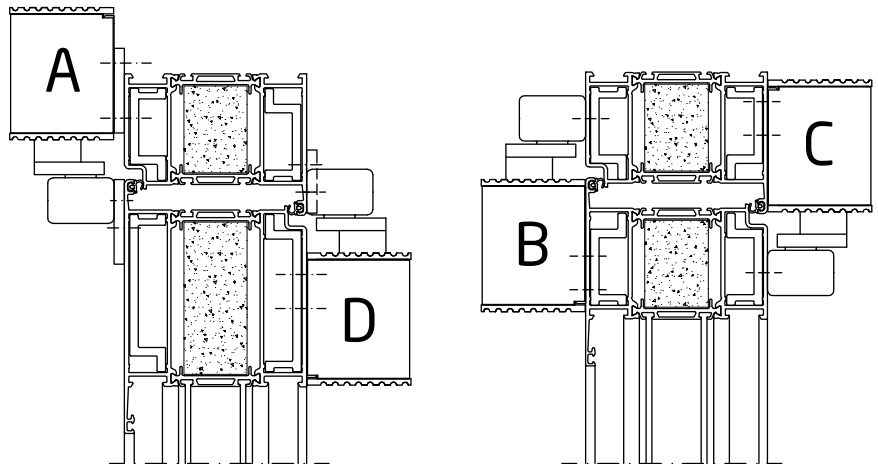

- A**= Mounting on hinge side
- C**= Mounting on hinge opposite side

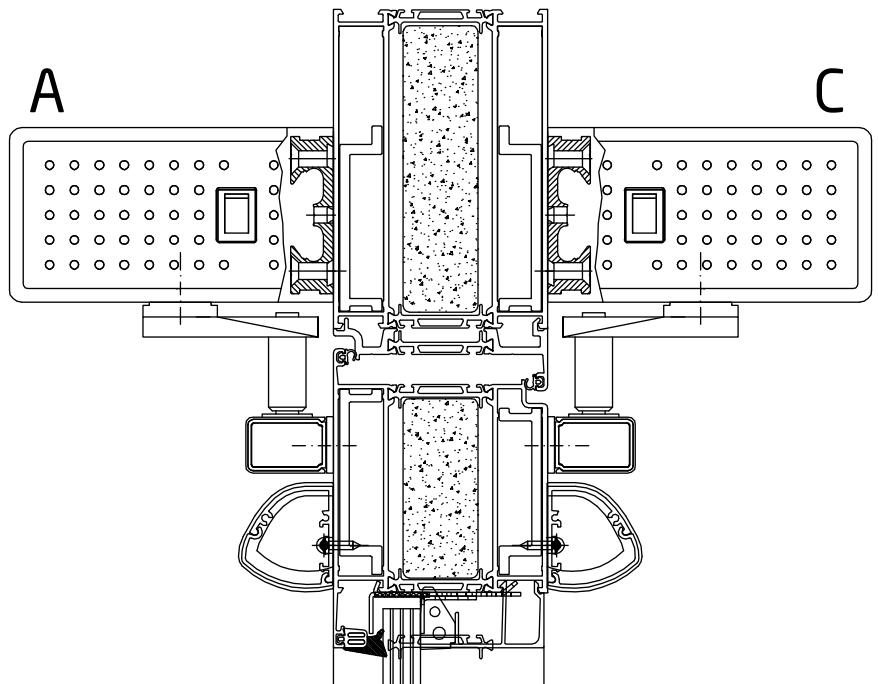

NB! There must always be a connected door closer alt. an automatic door operator in fire door. All automatics only approved when used in combination with lock latch.

Anti-panic fittings assembling:

- A.** The device at locking side of the primary door is fixed according to instructions from device supplier. At hinge side the device is fixed by screw, P/N 12709 (x4), through both section walls.
- B.** The device on the slave door is fixed by screw, P/N 12709 (x4). Similar installation for top, center and bottom.
- C.** At bottom the device of the slave door is locked to the striking plate, ASSA A92. The striking plate is fixed by screw of steel, M4 (x3).
- D.** At top the device of the primary door is locked to the striking plate, ASSA A96, in door frame. The striking plate is fixed by screw, P/N 12710 (x3). A spacer of approx. 5.5 mm is used for correct height to striking plate.

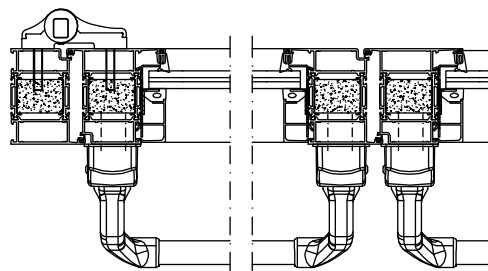
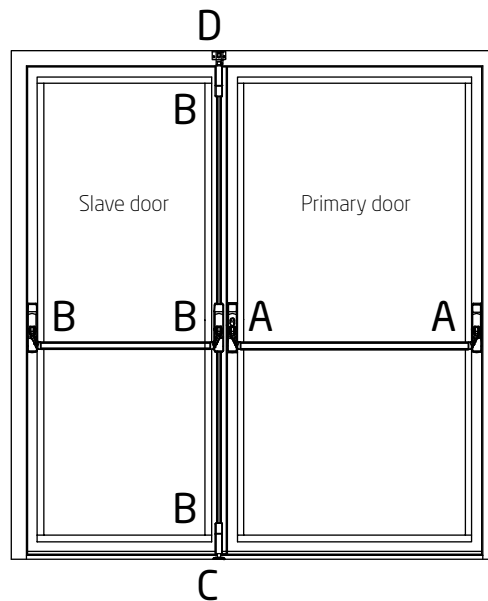

NB! Example above refer to ASSA 1130 and 1130:1 but similar assembly is recommended for other panic exit devices. Only screws will be included in delivery.

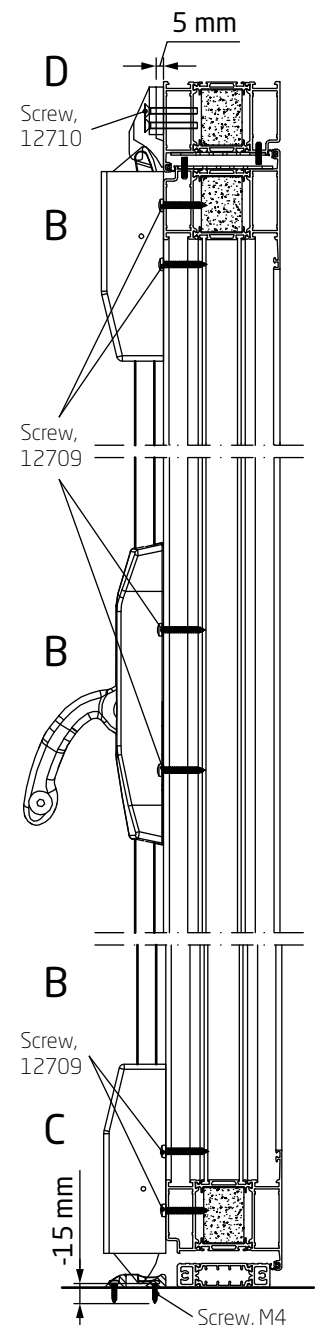

Cylinders and handles assembling:

External side between cylinder accessories, handle and door leaf needs to be sealed by sealing compound P/N 12222 (Applies to external constructions only).

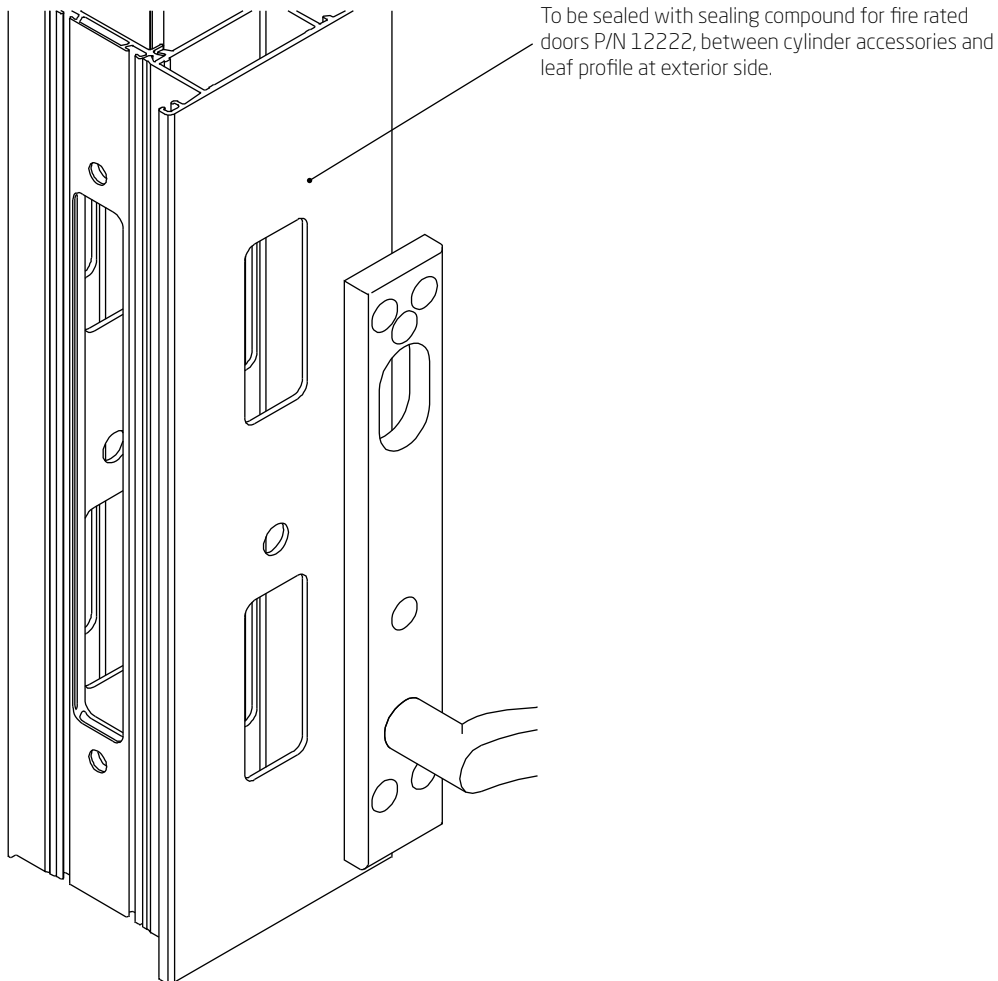

NB! Only cylinder accessories, handles in metal are approved in fire resistant doors.

Finger trap protection Athmer Fingerschutz BA-28 assembling on hinge side

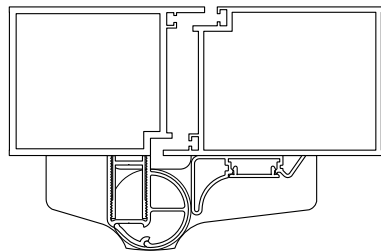
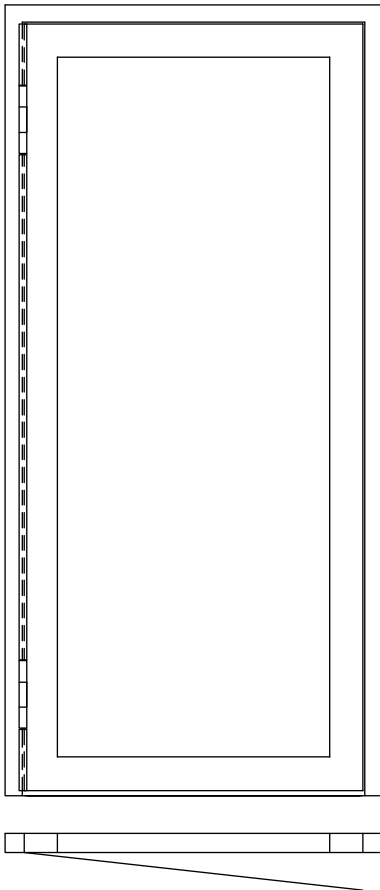

Slim design hinge (14090)

NB! Finger trap protection fits slim design hinges (14090)! Protection must be assembled with screws P/N 12138.

We recommend ordering finger trap protection's assembling in production. If installation will be conducted on site, follow installation guides of finger trap protection's manufacturer, included with delivery.

Finger trap protection Athmer Fingerschutz NR-32 assembling on opposite hinge side

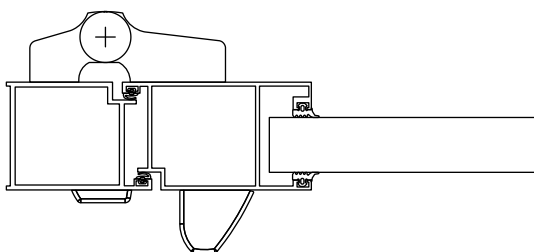
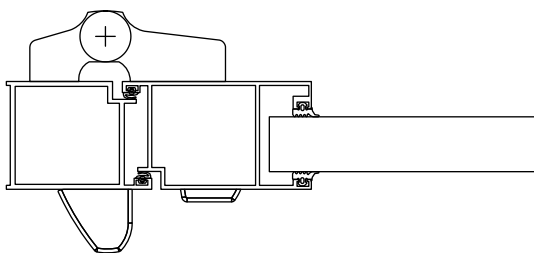
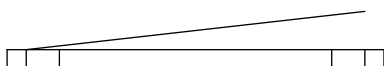
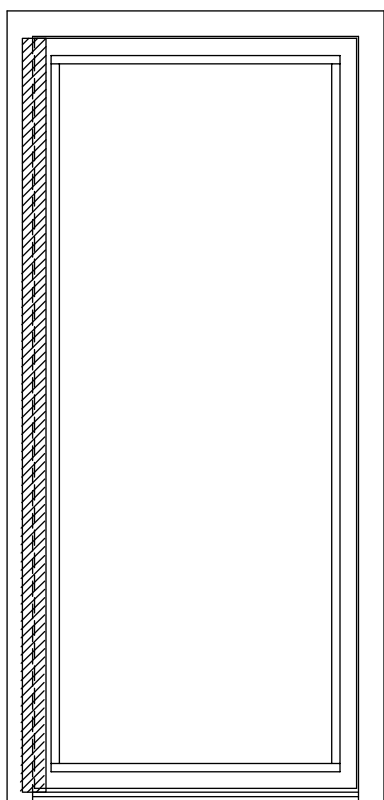

NB! Protection must be assembled with screws P/N 12163.

We recommend ordering finger trap protection's assembling in production. If installation will be conducted on site, follow installation guides of finger trap protection's manufacturer, included with delivery.